

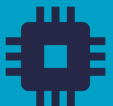

Subsystems for the
UAS integration into
the airspace

EVAL TT-Multi-RF

[Data sheet - User manual](#)

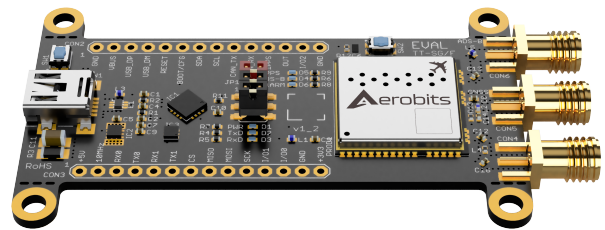

Contents

1	Introduction	3
1.1	Available variants	3
1.2	Features	3
2	Technical parameters	5
2.1	Basic technical information	5
2.2	Hardware and layout	5
2.3	Electrical specification	6
2.3.1	Absolute maximum ratings	6
2.3.2	Recommended operation conditions	6
2.3.3	General electrical parameters	6
2.3.4	Most important components	6
2.3.5	Connectors and jumpers	7
2.3.6	LED indicators	8
2.3.7	Layout	9
2.3.8	Electrical diagram	11
2.4	Mechanical specification	12
2.4.1	Dimensions	12
2.4.2	Connectors	12
3	Disclaimer	13

1 Introduction

The evaluation kit provides a quick introduction to the **TT-Multi-RF** module. **EVAL-TT-Multi-RF** with the dedicated software allows the user to discover the module properties within a short time, paving the way towards quick prototyping. The software allows simple configuration of the module and data visualization in various modes, from raw data, through tabular and 3D views.

Note:

The device to operate on FLARM frequency requires FLARM UAS license. The license must be obtained with the device from Aerobits upon purchase. FLARM library expire after year and must be updated with latest firmware.

Important:

Each firmware version becomes its own documentation. This document is relevant for firmware version v2.82.1. If your firmware version is different please find relevant documentation on our website aerobits.pl.

1.1 Available variants

Table 1: Variants of TT-Multi-RF module

Variant	ADS-B	GNSS	FLARM	UAT	Note
SF2	✓	✓	✓		
SF2n	✓		✓		(*)
SU2	✓	✓		✓	
SU2n	✓			✓	
SG2	✓	✓			

Important:

* - FLARM to function properly requires precise time synchronization. This normally is achieved by connecting the module to a GNSS source. If GNSS is not available, the module has to be feed with GNSS NMEA sentences and PPS from external source.

1.2 Features

- **Receiving of ADS-B, Mode-A/C/S with RF signal strength/quality analysis**
- **Time stamp (raw data only) for multilateration**
- **Multiple supported protocols, i.a. RAW HEX, CSV, AERO, MAVLink, ASTERIX, GDL90**
- **Integrated high quality GNSS position source**
- **Licensed FLARM transceiver**
- **Receiving of UAT**
- **High-resolution ADC with real-time signal processing; best-in-class aircraft tracking**
- **Simple module integration via USB or UART interface and AT commands**

- **Scalable OEM solution with enormous customization potential (additional functions or interfaces on request)**
- **Firmware update capability (uC and FPGA)**
- **Designed to meet MOPS defined in TSO-C199**

For more information please contact support@aerobits.pl.

2 Technical parameters

2.1 Basic technical information

Table 2: General technical parameters

Parameter	Description	Typ.	Unit
First Band	ADS-B	1090	MHz
Second Band	FLARM	868 or 915	MHz
Third Band	UAT	978	MHz
Fourth Band	GNSS	1575	MHz
Sensitivity (ADS-B)		-94	dBm
Sensitivity (FLARM)		-109	dBm
Sensitivity (UAT)		-110	dBm
Sensitivity (GNSS)		-167	dBm
RF Output power (FLARM)		+14	dBm
UART	AT commands	921600	bps
USB	AT commands		
MSL	Moisture Sensitivity Level	4	

2.2 Hardware and layout

The EVAL-TT-Multi-RF is designed around the OEM TT-Multi-RF module. It uses all I/Os, as well as custom I/Os (unused by the standard firmware). The top layer may be found [Top view of EVAL-TT-Multi-RF](#) (page 5)

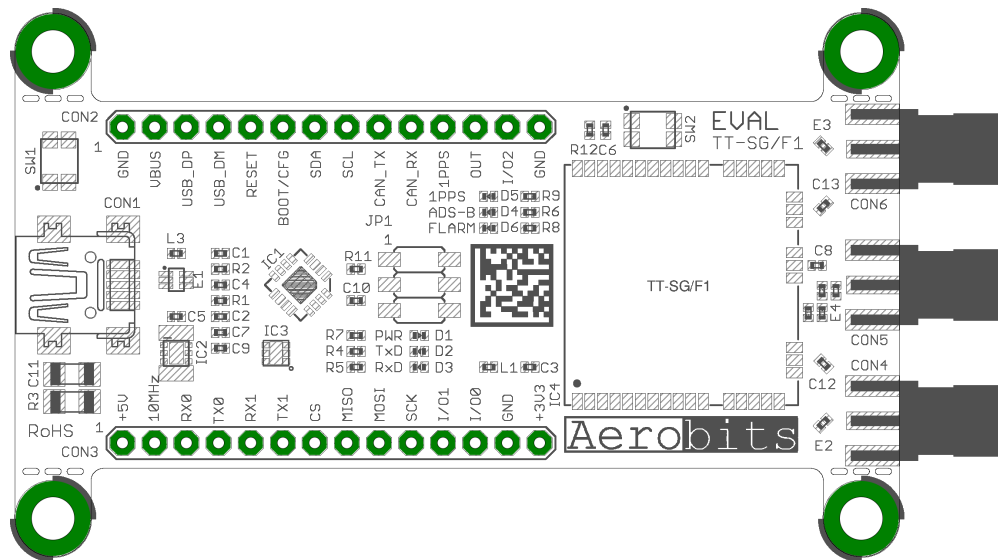

Fig. 1: Top view of EVAL-TT-Multi-RF

2.3 Electrical specification

2.3.1 Absolute maximum ratings

Table 3: Absolute maximum ratings.

Parameter	Min	Max	Unit
Storage temperature	-5	+40	°C
Supply voltage (VCC)	2.7	3.6	DCV
Supply voltage (via USB)	4.75	5.25	DCV
Other pin voltage	-0.3	VCC + 0.3	DCV
RF input ADS-B	–	+10	dBm
RF input FLARM	–	+10	dBm
RF input GNSS	–	0	dBm
RF input UAT	–	+10	dBm

2.3.2 Recommended operation conditions

Table 4: Recommended operation conditions.

Parameter	Min	Typ	Max	Unit
Operation temperature	-30	–	+85	°C
Supply voltage (VCC)	3.0	3.3	3.6	DCV
Supply voltage (via USB)	4.9	5.0	5.1	DCV

2.3.3 General electrical parameters

Table 5: General electrical parameters.

Parameter	Description	Min	Typ	Max	Unit
Current consumption		–	260	–	mA
Input Low Voltage	RESET, UARTs, CAN, USB, SPI, I2C	-0.3	–	0.8	DCV
Input High Voltage	RESET, UARTs, CAN, USB, SPI, I2C, GPIO	-0.3	–	0.8	DCV
Output Low Voltage	UARTs, CAN, USB, I2C, SPI, GPIO	–	–	0.4	DCV
Output High Voltage	UARTs, CAN, USB, I2C, SPI, GPIO	VCC - 0.4	–	–	DCV

2.3.4 Most important components

Pin arrangement of EVAL-TT-Multi-RF is shown on the figure below:

Table 6: Most important components.

RefNo	Description
CON1	Mini USB connector
CON2	Extensions connector I
CON3	Extensions connector II
CON4	FLARM/UAT RF Input
CON5	GNSS RF Input
CON6	ADS-B RF Input
JP1	Jumper group
SW1(C)	BOOT/CONFIG switch
SW2(R)	RESET switch

continues on next page

Table 6 – continued from previous page

RefNo	Description
D1	POWER LED
D2	UART TX LED
D3	UART RX LED
D4	SYSTEM/ADS-B LED
D5	1PPS LED
D6	FLARM/UAT LED
IC4	OEM TT-SF1

2.3.5 Connectors and jumpers

Table 7: Connector CON2 description.















CON2	No.	Marking	Function
	1	GND	Ground
	2	VUSB	Power supply of USB
	3	USB_DP	USB: D+ line
	4	USB_DM	USB: D- line
	5	RESET	Reset signal
	6	BOOT/CFG	BOOT/CONFIG signal
	7	SDA	I2C: data line
	8	SCL	I2C: clock line
	9	CAN_TX	CAN: transmit line
	10	CAN_RX	CAN: receive line
	11	1PPS	GNSS: 1 pulse per second input (time reference)
	12	OUT	SYSTEM/ADS-B LED
	13	I/O2	FLARM LED
	14	GND	Ground

Table 8: Connector CON3 description.

















CON3	No.	Marking	Function
	1	+5V	5V Power supply
	2	+10MHz	Reserved
	3	RX0	UART0 – Receive line
	4	TX0	UART0 – Transmit line
	5	RX1	UART1 – Receive line
	6	TX1	UART1 – Transmit line
	7	CS	SPI – Chip select
	8	MISO	SPI – MISO signal
	9	MOSI	SPI – MOSI signal
	10	SCK	SPI – Serial clock
	11	I/O0	Reserved
	12	I/O1	Reserved
	13	GND	Ground
	14	+3V3	3.3V Power supply

Table 9: Jumper group JP1 description.

JP1	No.	State	Function
	1	Closed	3.3V power supply provided by on-board regulator (default)
		Open	3.3V power supply provided by CON3 (PIN14)
	2	Closed	UART TX via USB (default)
		Open	UART TX via CON3 (PIN4)
	3	Closed	UART RX via USB (default)
		Open	UART RX via CON3 (PIN3)

2.3.6 LED indicators

Table 10: LED indicators.

LED	Color	Description
D1	Green	ON: Power supply
D2	Red	ON: OEM TT-SF1 transmitting data
D3	Yellow	ON: OEM TT-SF1 receiving data
D4	White	In BOOTLOADER state: continuous on In CONFIGURATION state: blinking at 5Hz In RUN state: 1 blink for every ADS-B frame received
D5	White	Blink when GNSS is fixed (1Hz)
D6	White	Blink every FLARM/UAT frame received

2.3.7 Layout

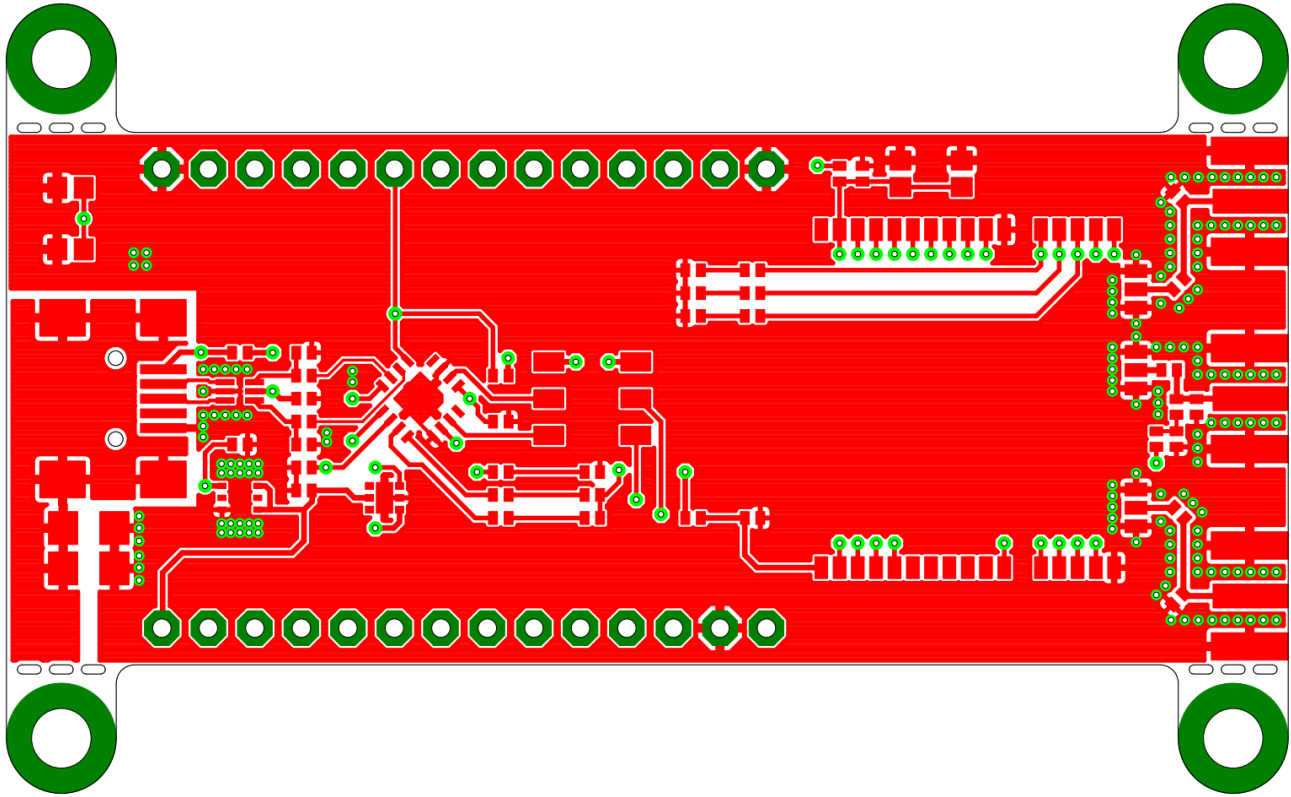

Fig. 2: Top copper layer of EVAL-TT-Multi-RF

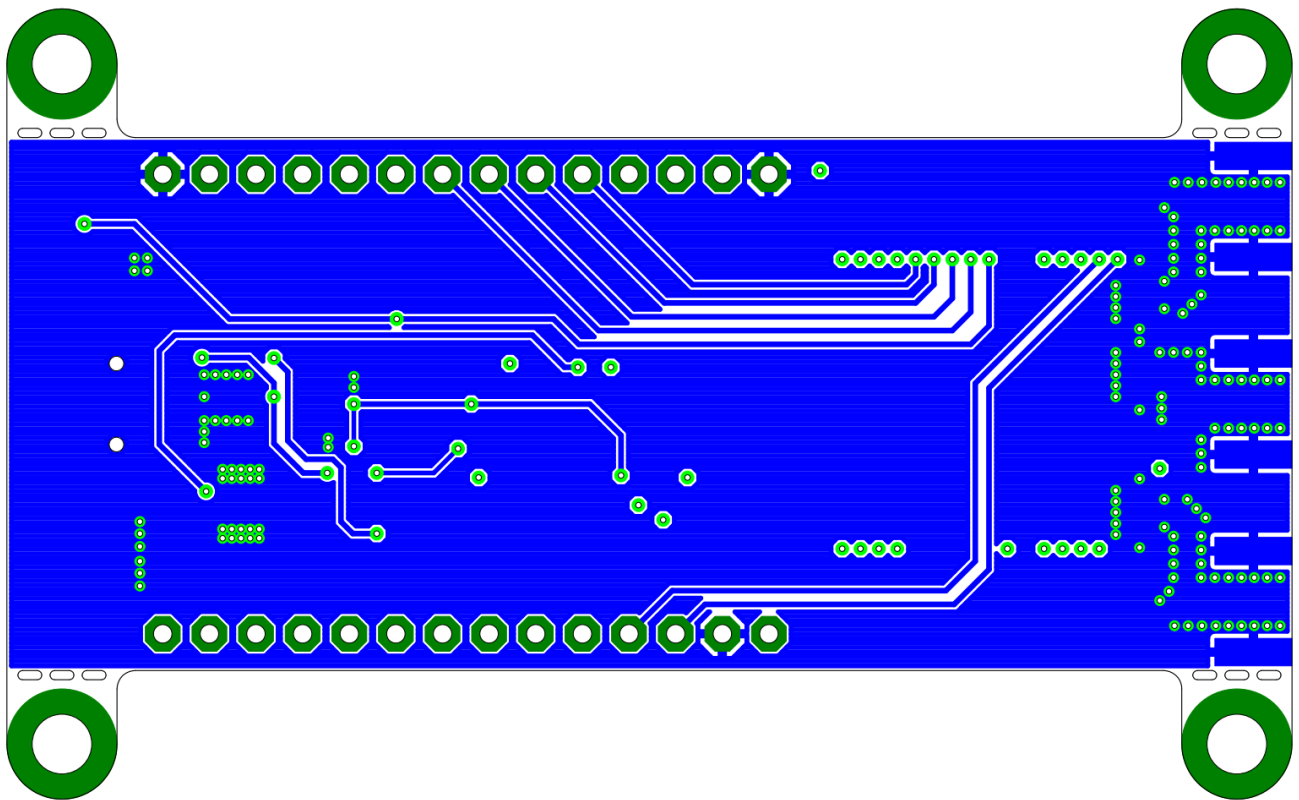

Fig. 3: Bottom copper layer of EVAL-TT-Multi-RF

2.3.8 Electrical diagram

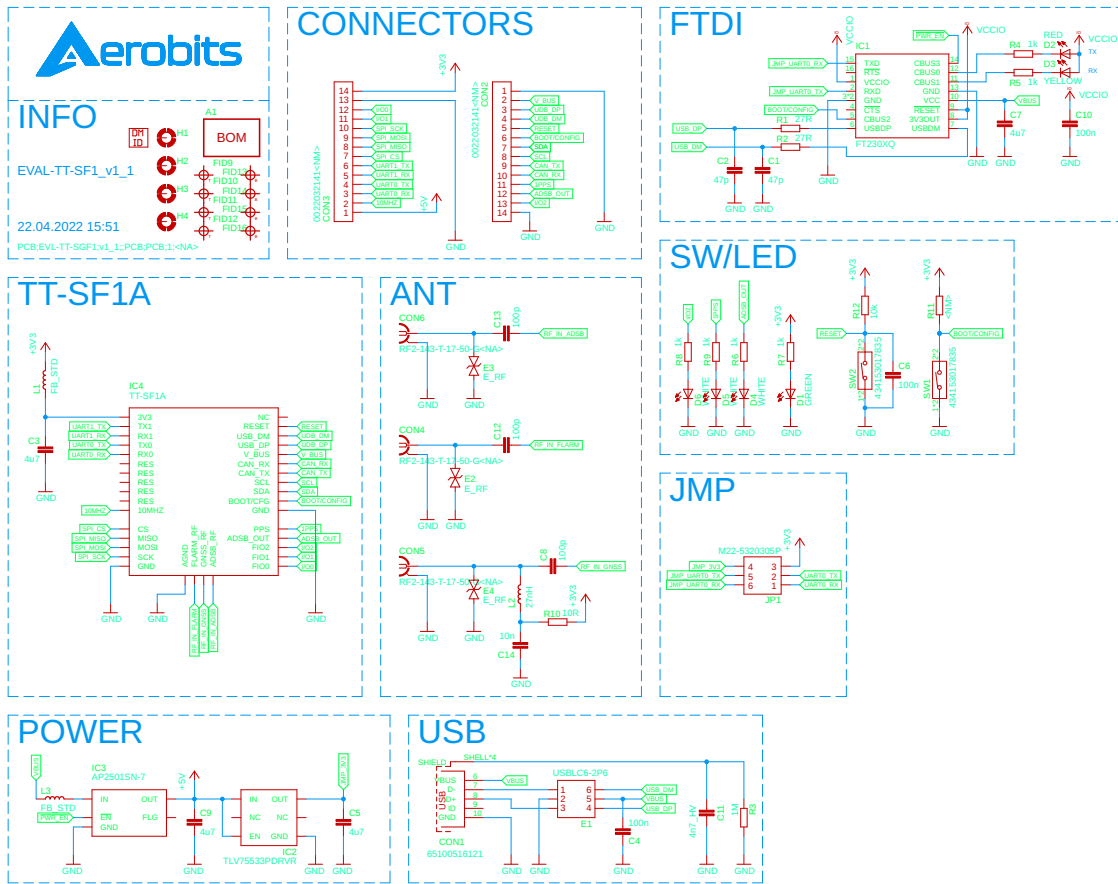

Fig. 4: Electrical diagram of EVAL-TT-Multi-RF

2.4 Mechanical specification

2.4.1 Dimensions

Table 11: Absolute maximum ratings.

Parameter	Value
Dimensions	70.0 x 29.0 x 1.5 mm
Weight	16.5 g

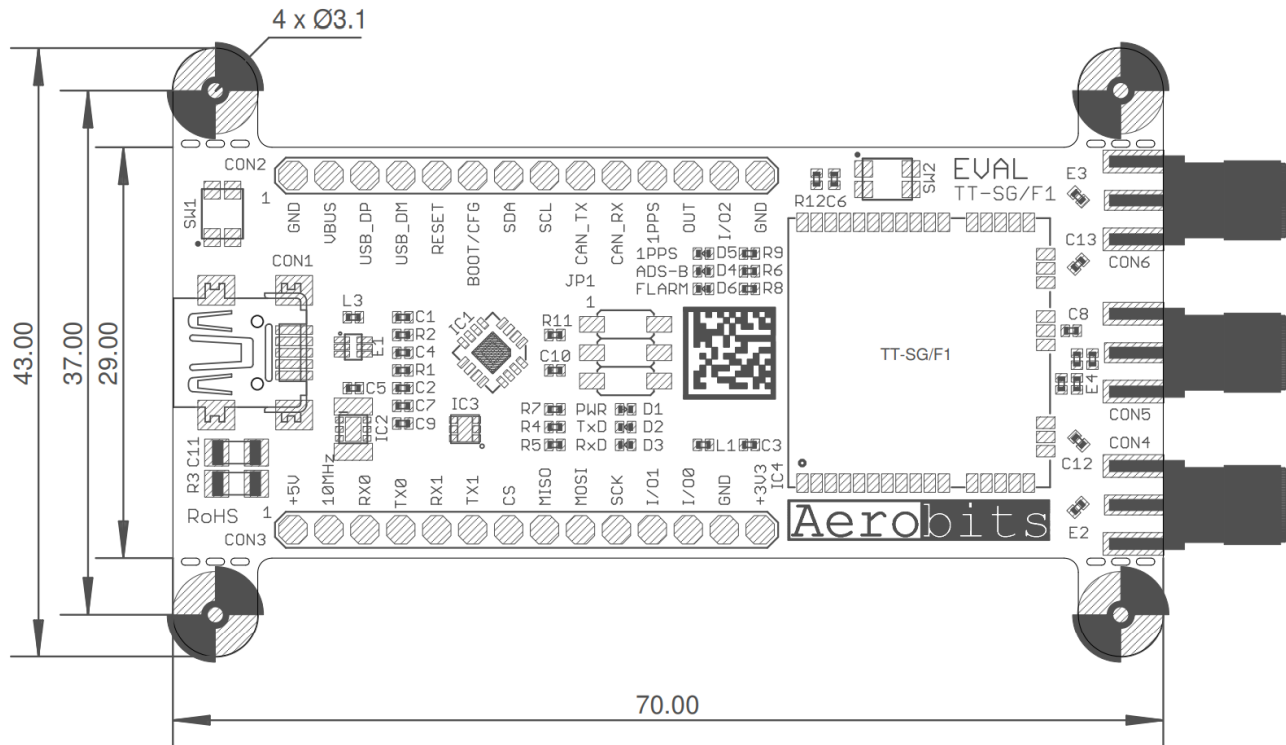

Fig. 5: Footprint of EVAL-TT-Multi-RF

2.4.2 Connectors

Table 12: Descriptions of used connectors.

Description	Type	Function	Mating connector
CON4/CON5/CON6	RF2-143-T-17-50-G	RF connector	RF2-01A-02-50-G
CON1	65100516121	Power and Data	CBL-UA-MB-15WP

3 Disclaimer

Information contained in this document is provided solely in connection with Aerobits products. Aerobits reserves the right to make changes, corrections, modifications or improvements to this document, and to products and services described herein at any time, without notice. All Aerobits products are sold pursuant to our own terms and conditions of sale. Buyers are solely responsible for the choice, selection and use of the Aerobits products and services described herein, and Aerobits assumes no liability whatsoever, related to the choice, selection or use of Aerobits products and services described herein. No license, express or implied, by estoppel or otherwise, to any intellectual property rights is granted under this document. If any part of this document refers to any third party products or services, it shall not be deemed a license granted by Aerobits for use of such third party products or services, or any intellectual property contained therein or considered as a warranty covering use, in any manner whatsoever, of such third party products or services or any intellectual property contained therein.

UNLESS OTHERWISE SET FORTH IN AEROBITS TERMS AND CONDITIONS OF SALE, AEROBITS DISCLAIMS ANY EXPRESS OR IMPLIED WARRANTY WITH RESPECT TO USE AND/OR SALE OF AEROBITS PRODUCTS INCLUDING, WITHOUT LIMITATION, IMPLIED WARRANTIES OF MERCHANTABILITY, FITNESS FOR A PARTICULAR PURPOSE (AND THEIR EQUIVALENTS UNDER THE LAWS OF ANY JURISDICTION), OR INFRINGEMENT OF ANY PATENT, COPYRIGHT OR OTHER INTELLECTUAL PROPERTY RIGHT. UNLESS EXPRESSLY APPROVED IN WRITING BY AN AUTHORIZED AEROBITS REPRESENTATIVE, AEROBITS PRODUCTS ARE NOT RECOMMENDED, AUTHORIZED OR WARRANTED FOR USE IN LIFE SAVING, OR LIFE SUSTAINING APPLICATIONS, NOR IN PRODUCTS OR SYSTEMS WHERE FAILURE OR MALFUNCTION MAY RESULT IN PERSONAL INJURY, DEATH, OR SEVERE PROPERTY OR ENVIRONMENTAL DAMAGE.

Information in this document supersedes and replaces all previously supplied information.

© 2024 Aerobits - All rights reserved