

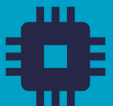

Subsystems for the
UAS intergration into
the airspace

EVAL TT-SU2

[Data sheet & User manual](#)



Introduction

The evaluation kit provides a quick introduction to the TT-SU2 module. It is a high quality 1090 MHz band receiver with an integrated ADS-B (Automatic Dependent Surveillance - Broadcast) decoder, conforming to MOPSS specified in TSO-C199. The TT-SU2 module contains also internal GNSS module (Ublox), to utilize concurrent reception of up to three GNSS systems (GPS / Galileo together with BeiDou or GLONASS). Other key feature is implemented UAT (Universal Access Transceivers) 978 MHz band receiver which supports multiple broadcast services, including flight information services (FIS-B) and traffic information services (TIS-B), in addition to automatic dependent surveillance — broadcast (ADS-B).

EVAL-TT-SU2 with the dedicated software allows the user to discover the module properties within a short time, paving the way towards quick prototyping. The software allows simple configuration of the module and data visualization in various modes, from raw data, through tabular and 3D views.

[Check all our evaluation kits here](#)

For more information please contact: support@aerobits.pl.

Contents

1	Technical parameters	3
1.1	Hardware and layout	3
2	Electrical specification	4
2.1	Power supply	4
2.2	Most important components	4
2.3	Connectors and jumpers	4
2.4	LED indicators	5
2.5	Layout	6
2.6	Electrical diagram	7
3	Mechanical specification	8
3.1	Mechanical parameters	8
3.2	Dimensions	8

1 Technical parameters

General Technical Parameters				
Parameter	Min.	Typ.	Max.	Unit
Carrier frequency ADS-B	-	1090	-	MHz
RX sensitivity ADS-B	-	approx. -85	-	dBm
RX sensitivity GNSS	-	approx. -167	-	dBm
RX sensitivity UAT	-	approx. -95	-	dBm
AERO (baud)	115200	921600	3000000	bps
Operation temperature	-30		+85	°C
Storage temperature	-5		+40	°C

Table 1: General technical parameters.

1.1 Hardware and layout

The EVAL TT-SU2 is designed around the OEM TT-SU2 module. It uses all I/Os, as well as custom I/Os (unused by the standard firmware). The top layer may be found in fig. 1.

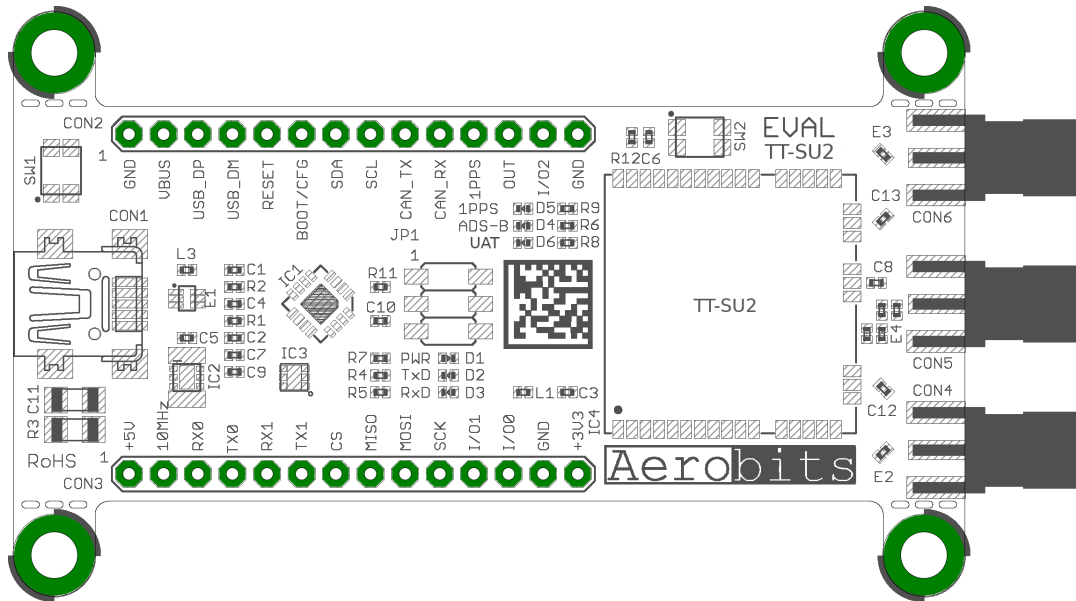

Figure 1: Top view of EVAL TT-SU2.

2 Electrical specification

2.1 Power supply

Parameter	Value
Power connector	Standard mini USB connector
Power consumption	260 mA
Power supply	3.3V 5V(RF) (recommend mini USB Supply)

Table 2: Power supply of EVAL TT-SU2

2.2 Most important components

RefNo	Description
CON1	Mini USB connector
CON2	Extensions connector I
CON3	Extensions connector II
CON4	UAT RF Input
CON5	GNSS RF Input
CON6	ADS-B RF Input
JP1	Jumper group
SW1(C)	BOOT/CONFIG switch
SW2(R)	RESET switch
D1	POWER LED
D2	UART TX LED
D3	UART RX LED
D4	SYSTEM/ADS-B LED
D5	1PPS LED
D6	UAT LED
IC4	OEM TT-SU2

Table 3: Most important components. See fig. 1

2.3 Connectors and jumpers

CON2	No.	Marking	Function
	1	GND	Ground
	2	VUSB	Power supply of USB
	3	USB_DP	USB: D+ line
	4	USB_DM	USB: D- line
	5	RESET	Reset signal
	6	BOOT/CFG	BOOT/CONFIG signal
	7	SDA	I2C: data line
	8	SCL	I2C: clock line
	9	CAN_TX	CAN: transmit line
	10	CAN_RX	CAN: receive line
	11	1PPS	GNSS: 1 pulse per second input (time reference)
	12	OUT	SYSTEM/ADS-B LED
	13	I/O2	UAT LED
	14	GND	Ground

Table 4: Connector CON2 description.

CON3	No.	Marking	Function
	1	+5V	5V Power supply
	2	+10MHz	Reserved
	3	RX0	UART0 – Receive line
	4	TX0	UART0 – Transmit line
	5	RX1	UART1 – Receive line
	6	TX1	UART1 – Transmit line
	7	CS	SPI – Chip select
	8	MISO	SPI – MISO signal
	9	MOSI	SPI – MOSI signal
	10	SCK	SPI – Serial clock
	11	I/O0	Reserved
	12	I/O1	Reserved
	13	GND	Ground
	14	+3V3	3.3V Power supply

Table 5: Connector CON3 description.

JP1	No.	State	Function
	1	Closed	3.3V power supply provided by on-board regulator (default)
		Open	3.3V power supply provided by CON3 (PIN14)
	2	Closed	UART TX via USB (default)
		Open	UART TX via CON3 (PIN4)
	3	Closed	UART RX via USB (default)
		Open	UART RX via CON3 (PIN3)

Table 6: Jumper group JP1 description.

2.4 LED indicators

LED	Color	Description
D1	Green	ON: Power supply
D2	Red	ON: OEM TT-SU2 transmitting data
D3	Yellow	ON: OEM TT-SU2 receiving data
D4	White	In BOOTLOADER state: continuous on In CONFIGURATION state: blinking at 5Hz In RUN state: 1 blink for every ADS-B frame received
D5	White	Blink when GNSS is fixed (1Hz)
D6	White	Blink every UAT frame received

2.5 Layout

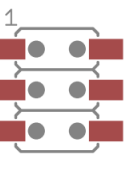
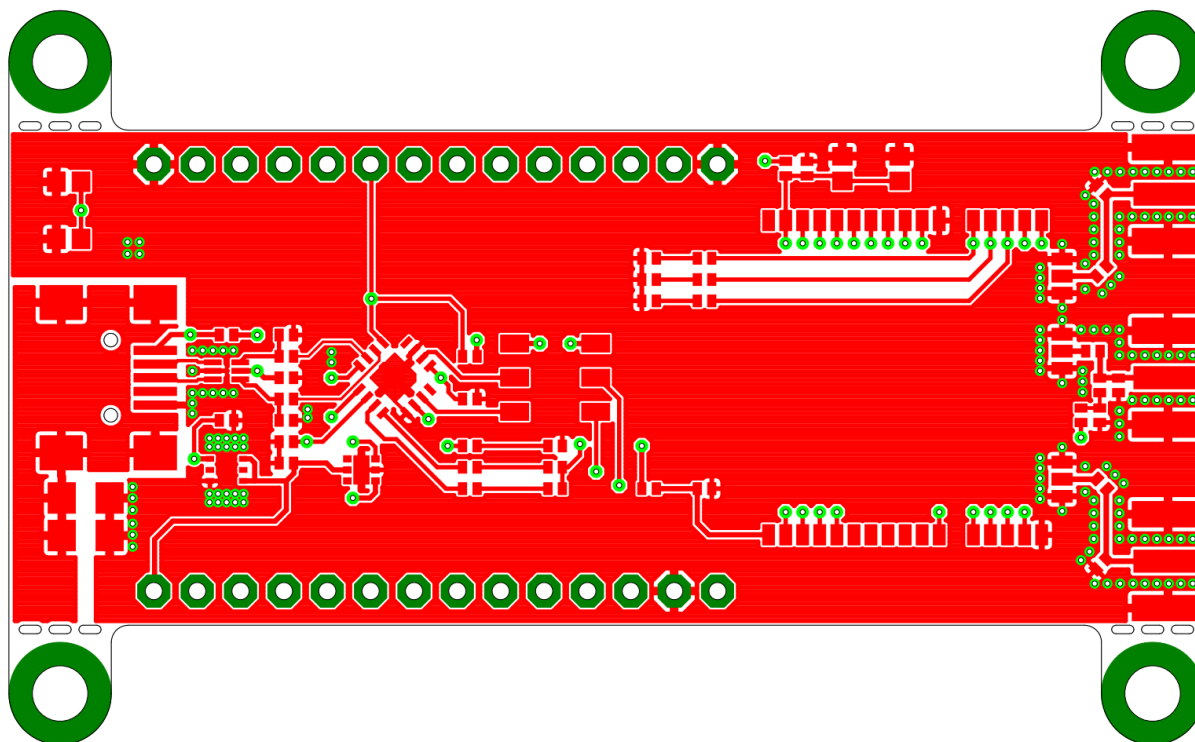

Figure 2: Top copper layer of EVAL TT-SU2

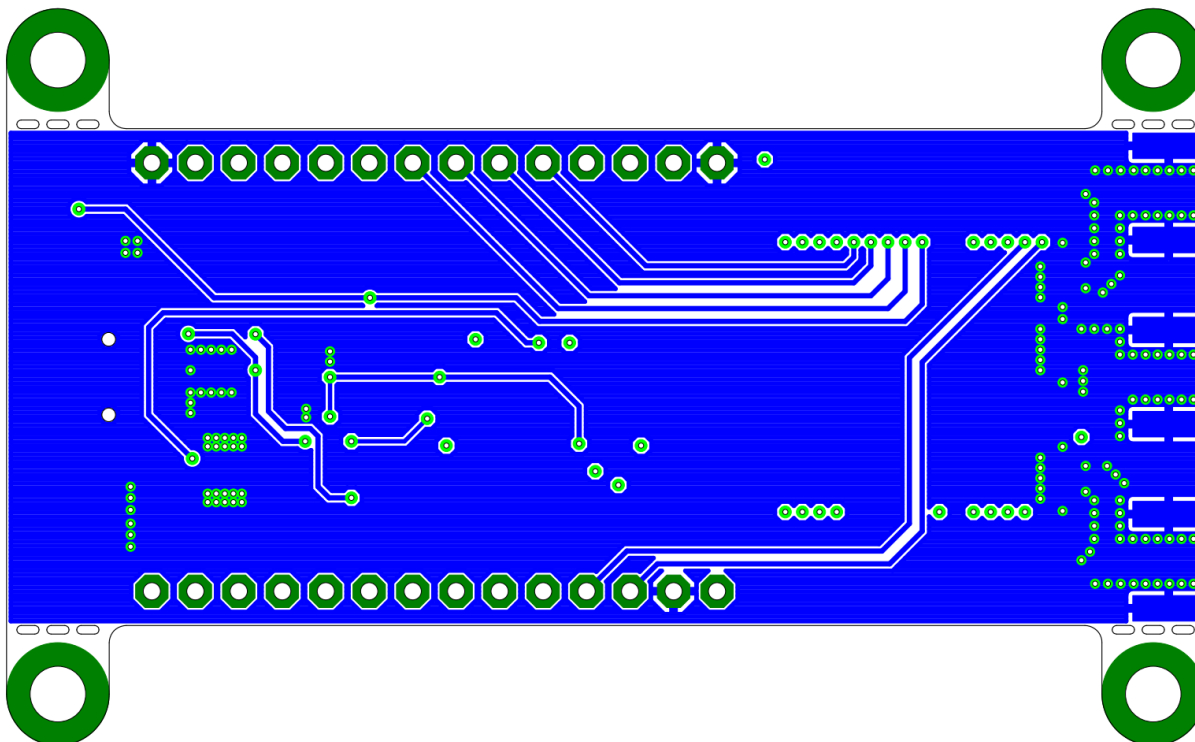

Figure 3: Bottom copper layer of EVAL TT-SU2

2.6 Electrical diagram

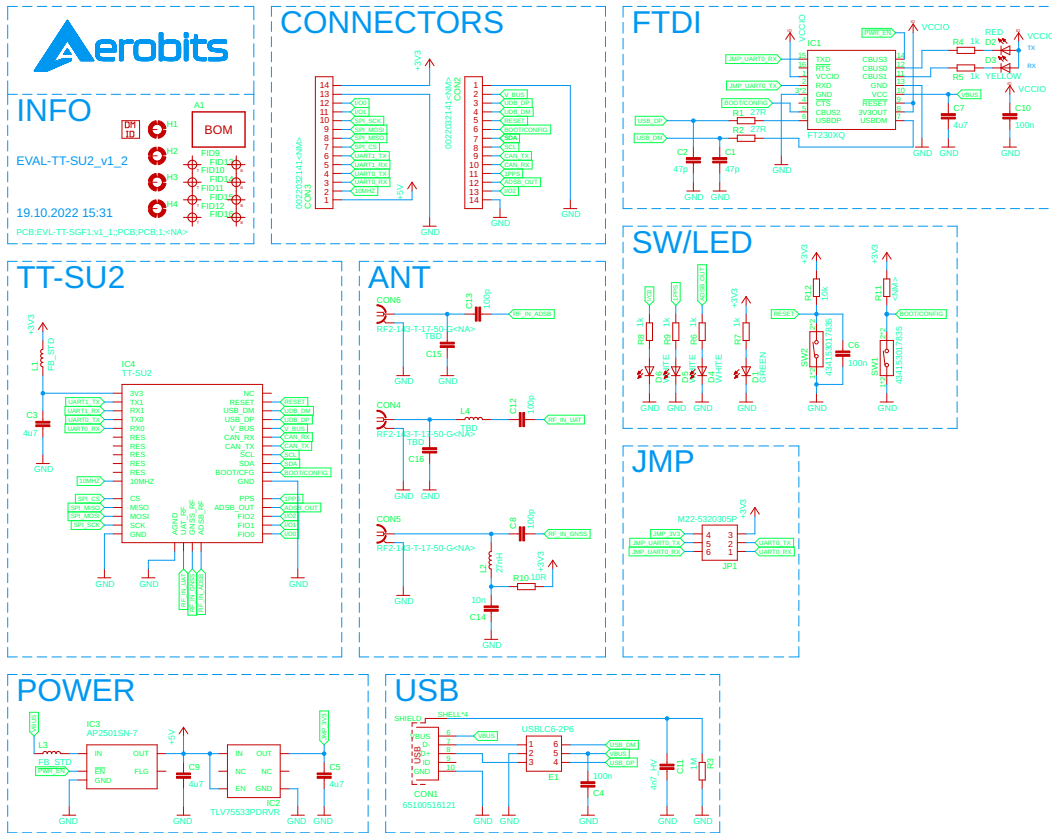

Figure 4: Electrical diagram of EVAL TT-SU2

3 Mechanical specification

3.1 Mechanical parameters

Parameter	Value
Dimensions	70.0 x 29.0 x 1.5 mm
Weight	16.5 g

Table 7: Mechanical parameters of EVAL TT-SU2

3.2 Dimensions

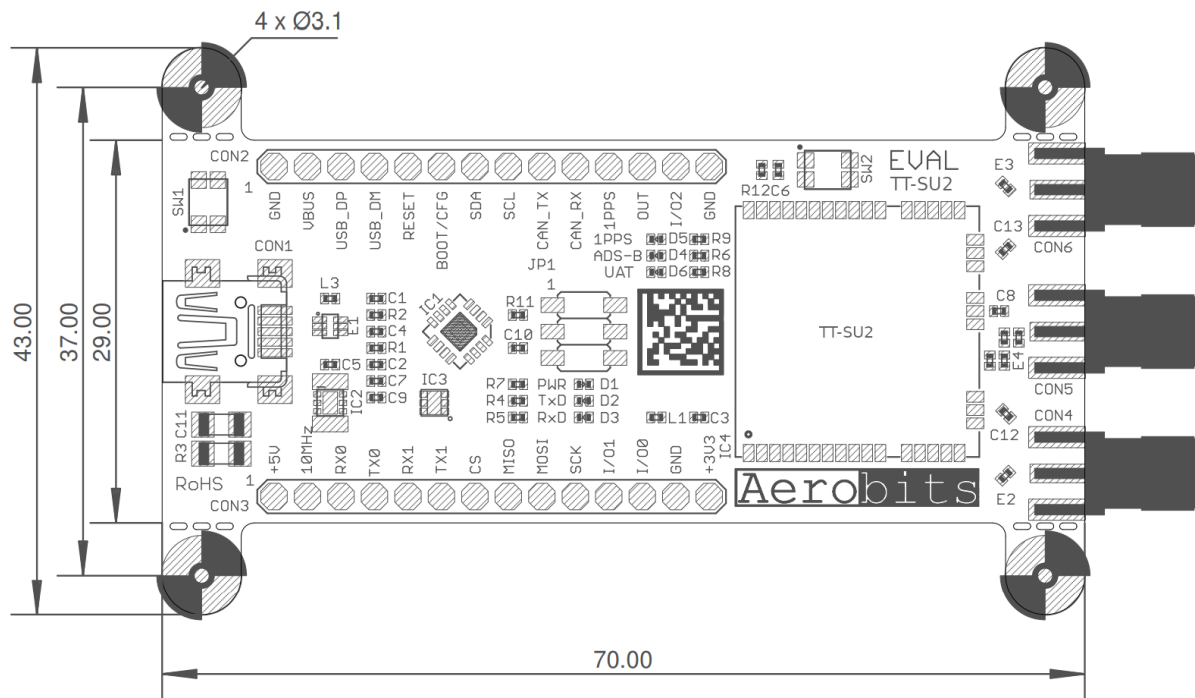

Figure 5: Dimensions of EVAL TT-SU2

NOTE: For more specific information see [OEM ADS-B receiver - TT-SU2](#)

Please read carefully

Information contained in this document is provided solely in connection with Aerobits products. Aerobits reserves the right to make changes, corrections, modifications or improvements to this document, and to products and services described herein at any time, without notice. All Aerobits products are sold pursuant to our own terms and conditions of sale. Buyers are solely responsible for the choice, selection and use of the Aerobits products and services described herein, and Aerobits assumes no liability whatsoever, related to the choice, selection or use of Aerobits products and services described herein. No license, express or implied, by estoppel or otherwise, to any intellectual property rights is granted under this document. If any part of this document refers to any third party products or services, it shall not be deemed a license granted by Aerobits for use of such third party products or services, or any intellectual property contained therein or considered as a warranty covering use, in any manner whatsoever, of such third party products or services or any intellectual property contained therein.

UNLESS OTHERWISE SET FORTH IN AEROBITS TERMS AND CONDITIONS OF SALE, AEROBITS DISCLAIMS ANY EXPRESS OR IMPLIED WARRANTY WITH RESPECT TO USE AND/OR SALE OF AEROBITS PRODUCTS INCLUDING, WITHOUT LIMITATION, IMPLIED WARRANTIES OF MERCHANTABILITY, FITNESS FOR A PARTICULAR PURPOSE (AND THEIR EQUIVALENTS UNDER THE LAWS OF ANY JURISDICTION), OR INFRINGEMENT OF ANY PATENT, COPYRIGHT OR OTHER INTELLECTUAL PROPERTY RIGHT. UNLESS EXPRESSLY APPROVED IN WRITING BY AN AUTHORIZED AEROBITS REPRESENTATIVE, AEROBITS PRODUCTS ARE NOT RECOMMENDED, AUTHORIZED OR WARRANTED FOR USE IN LIFE SAVING, OR LIFE SUSTAINING APPLICATIONS, NOR IN PRODUCTS OR SYSTEMS WHERE FAILURE OR MALFUNCTION MAY RESULT IN PERSONAL INJURY, DEATH, OR SEVERE PROPERTY OR ENVIRONMENTAL DAMAGE.

Information in this document supersedes and replaces all previously supplied information.
© 2023 Aerobits - All rights reserved